

All dimensions in mm.

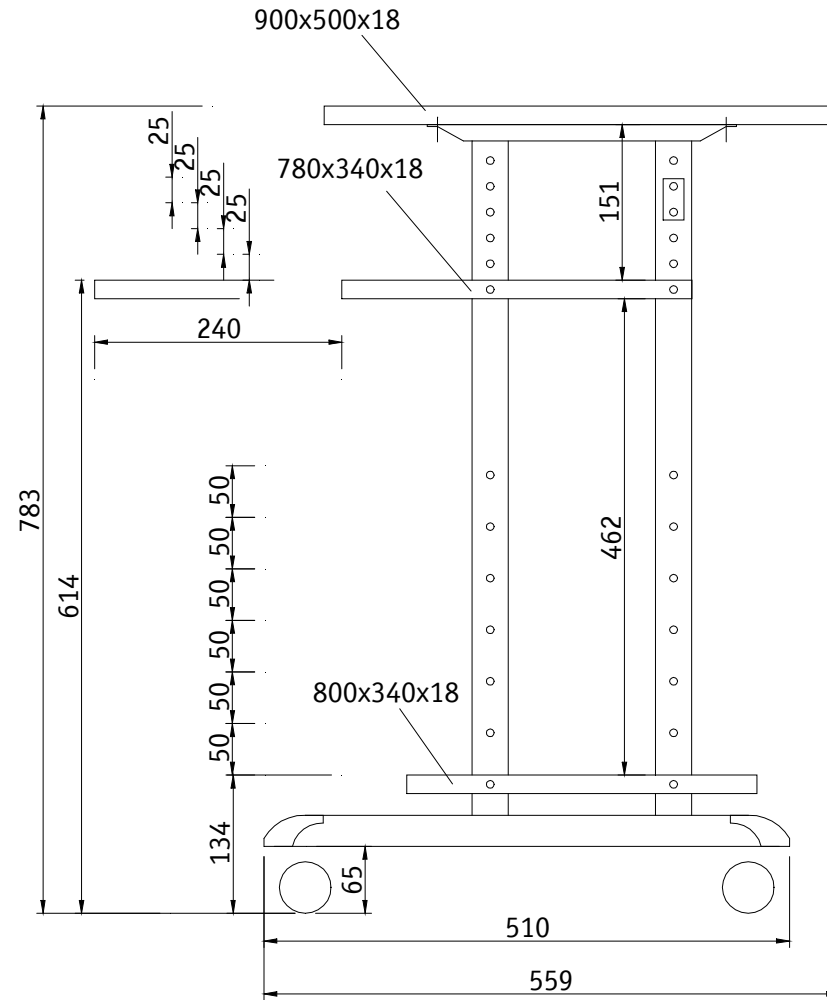

DATA-INFO
85.840/3/5

Dataflex®
is a registered
trademark of
VIKING A.C. EUROPE BV
P.O. Box 713
NL-2920 CA
Krimpen a/d IJssel